

GaAs Pseudomorphic HEMT Transistor

Features

- ✕ High Gain: Usable to 44 GHz
- ✕ Low Noise Figure 0.8 dB @ 12 GHz
- ✕ Wafer Qualification Procedure
- ✕ Customer Wafer Selection Available

General Description

Mimix CF001-03 GaAs-based transistor is a 300 um gate width, sub-half-micron gate length GaAs device with Silicon Nitride passivation. The CF001-03 is suitable for narrow and wide band low noise and high gain amplifiers up to 40 GHz. The CF001-03 is available in chip form and is suitable for airborne, shipboard and ground-based equipment. The devices are 100% DC tested and every wafer is qualified based on sample RF and reliability testing. Screening includes MIL-STD-750 Class B, Class S and commercial screening. These devices are also available in packaged form. Please consult the CFS0103-SB, CFB0103-B, CFA0103-A datasheets or contact the factory for further information.

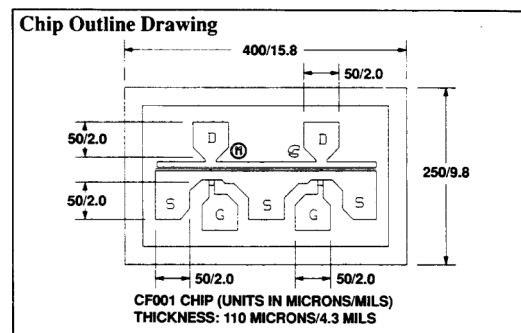

Absolute Maximum Ratings

Parameter	Symbol	Rating
Drain-Source Voltage	V _{DS}	8V
Gate-Source Voltage	V _{GS}	-5V
Drain Current	I _{DS}	I _{DSS}
Continuous Dissipation	P _T	800 mW
Channel Temperature	T _{CH}	175°C
Storage Temperature	T _{STG}	-65°C to +175°C

Specifications (T_A = 25°C)

CF001-03

Active Layer				Expitaxial		
Symbol	Parameters and Conditions	Frequency (GHz)	Units	Min	Typ	Max
NF _{opt}	Optimum Noise Figure V _{DS} = 3.0 V, I _{DS} = 15 mA	12.0	dB		1.2	1.8
Ga	Gain at NF _{opt} V _{DS} = 3.0 V, I _{DS} = 15 mA	12.0	dB	8.5	9.5	
S ₂₁ ²	50 Ohm Insertion Gain V _{DS} = 6.0 V, I _{DS} = 40 mA	2.0	dB		14.0	
		10.0	dB		10.5	
		18.0	dB		7.0	
P _{1dB}	Power Output @ 1 dB GC V _{DS} = 6.0 V, I _{DS} = 40 mA	12.0	dBm		17.0	
g _m	Transconductance V _{DS} = 3.0 V, V _{GS} = 0 V		mS		75	
I _{DSS}	Drain Current V _{DS} = 3.0 V, V _{GS} = 0 V		mA	30	60	120
V _p	Pinchoff Voltage V _{DS} = 3.0 V, I _{DS} = 1 mA		Volts	-0.5	-1.3	-2.5
BV _{GD}	Breakdown Voltage, Gate-Drain I _{GD} = 100 μA		Volts	-5.5	-8.0	
R _{th}	Thermal Resistance		°C/W		150	

GaAs Pseudomorphic HEMT Transistor

April 2008 - Rev 03-Apr-08

CF001-03

CF001-03

Typical Performance ($T_A = 25^\circ\text{C}$)

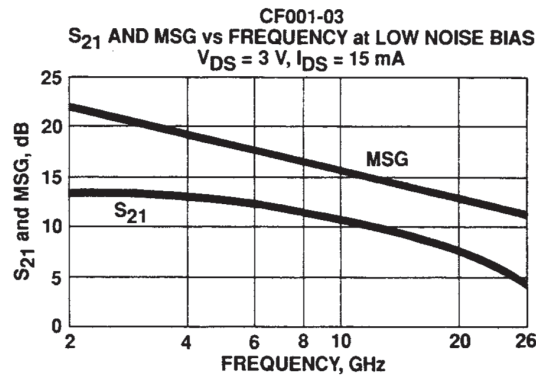
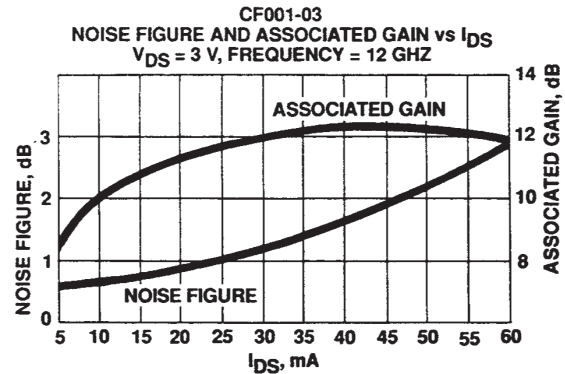
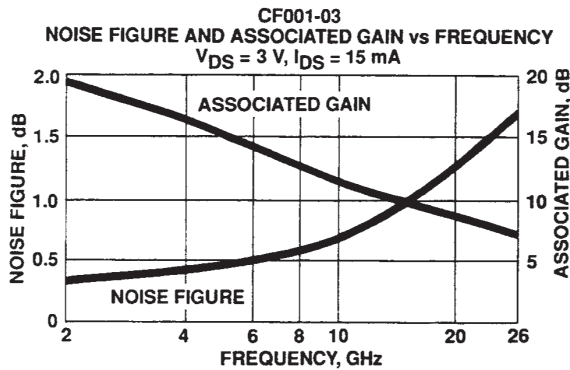

CF001-03
S₁₁ AND S₂₂ vs FREQUENCY at LOW NOISE BIAS
V_{DS} = 3 V, I_{DS} = 15 mA

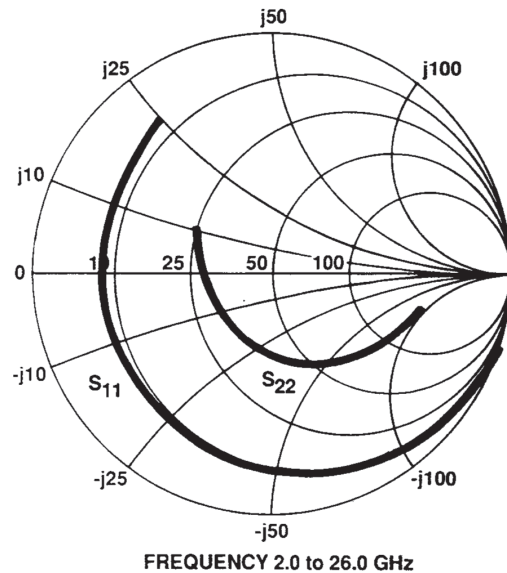

Typical Noise Parameters - CF001-03 V_{DS} = 3.0 V, I_{DS} = 15 mA

Frequency (GHz)	NF opt (dB)	Ga (dB)	Gamma opt (Mag)	Gamma opt (Ang)	Rn/50
2.0	0.35	19.4	0.85	9	0.69
4.0	0.43	16.2	0.76	19	0.48
6.0	0.51	14.0	0.70	35	0.38
8.0	0.60	12.4	0.65	54	0.31
10.0	0.70	11.4	0.60	73	0.26
12.0	0.80	10.8	0.55	90	0.21
14.0	0.91	10.2	0.52	107	0.17
16.0	1.02	9.8	0.49	123	0.12
18.0	1.14	9.3	0.48	142	0.09
20.0	1.27	8.8	0.49	162	0.06
22.0	1.40	8.2	0.53	-179	0.05
24.0	1.54	7.6	0.58	-165	0.05
26.0	1.68	7.0	0.58	-161	0.08

GaAs Pseudomorphic HEMT Transistor

April 2008 - Rev 03-Apr-08

CF001-03

Typical Scattering Parameters, Common Source (S-Parameters Include Bonding Wire Parasitics)

CF001-03 at Low Noise Bias

$V_{DS} = 3\text{ V}$, $I_{DS} = 15\text{ mA}$

Frequency (GHz)	S_{11}		S_{21}			S_{12}			S_{22}		K	MSG (dB)
	(Mag)	(Ang)	(dB)	(Mag)	(Ang)	(dB)	(Mag)	(Ang)	(Mag)	(Ang)		
2.0	0.99	-24	13.2	4.57	160	-30.8	0.03	76	0.57	-16	0.08	22.0
4.0	0.95	-50	12.9	4.43	140	-25.0	0.06	61	0.54	-32	0.16	19.0
6.0	0.90	-69	12.1	4.02	124	-22.7	0.07	50	0.52	-43	0.25	17.4
8.0	0.85	-93	11.5	3.76	106	-21.0	0.09	35	0.46	-60	0.33	16.2
10.0	0.79	-118	10.6	3.38	88	-20.5	0.09	20	0.40	-79	0.47	15.5
12.0	0.78	-139	9.8	3.08	73	-19.6	0.10	10	0.38	-95	0.46	14.7
14.0	0.77	-156	9.1	2.85	60	-19.4	0.11	1	0.35	-107	0.52	14.2
16.0	0.76	-171	8.6	2.69	46	-18.6	0.12	-8	0.31	-120	0.55	13.6
18.0	0.77	171	8.0	2.52	32	-18.2	0.12	-18	0.25	-142	0.59	13.1
20.0	0.76	152	7.4	2.35	16	-17.9	0.13	-29	0.22	-171	0.64	12.6
22.0	0.79	136	6.3	2.05	0	-17.7	0.13	-38	0.26	158	0.60	12.0
24.0	0.77	129	4.7	1.72	-10	-18.3	0.12	-39	0.30	145	0.78	11.5
26.0	0.80	125	3.6	1.52	-17	-18.2	0.12	-39	0.36	145	0.70	10.9

Device Model

Parameters	CF001-01	CF001-03	Units
	$V_{DS} = 6\text{ V}$, $I_{DS} = 40\text{ mA}$	$V_{DS} = 3\text{ V}$, $I_{DS} = 15\text{ mA}$	
L_g	0.19	0.26	nH
R_g	1.0	1.0	Ω
C_{gs}	0.32	0.24	pF
R_i	1.9	1.6	Ω
C_{gd}	0.023	0.029	pF
G_m	66	66	mS
τ	2.7	2.1	ps
C_{ds}	0.12	0.10	pF
R_{ds}	161	171	Ω
R_d	1.3	1.3	Ω
L_d	0.21	0.23	nH
R_s	1.1	1.6	Ω
L_s	0.04	0.04	nH

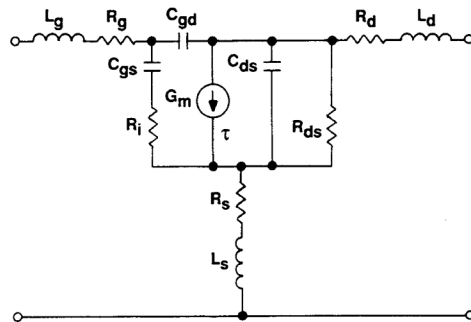

Wafer Qualification Procedure

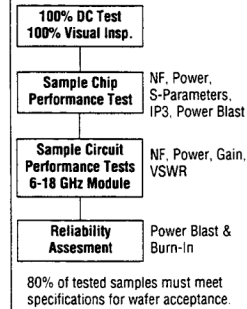

GaAs Pseudomorphic HEMT Transistor

Handling and Assembly Information

CAUTION! - Mimix Broadband MMIC Products contain gallium arsenide (GaAs) which can be hazardous to the human body and the environment. For safety, observe the following procedures:

- *Do not ingest.*
- *Do not alter the form of this product into a gas, powder, or liquid through burning, crushing, or chemical processing as these by-products are dangerous to the human body if inhaled, ingested, or swallowed.*
- *Observe government laws and company regulations when discarding this product. This product must be discarded in accordance with methods specified by applicable hazardous waste procedures.*

Life Support Policy - Mimix Broadband's products are not authorized for use as critical components in life support devices or systems without the express written approval of the President and General Counsel of Mimix Broadband. As used herein: (1) Life support devices or systems are devices or systems which, (a) are intended for surgical implant into the body, or (b) support or sustain life, and whose failure to perform when properly used in accordance with instructions for use provided in the labeling, can be reasonably expected to result in a significant injury to the user. (2) A critical component is any component of a life support device or system whose failure to perform can be reasonably expected to cause the failure of the life support device or system, or to affect its safety or effectiveness.

ESD - Gallium Arsenide (GaAs) devices are susceptible to electrostatic and mechanical damage. Die are supplied in antistatic containers, which should be opened in cleanroom conditions at an appropriately grounded antistatic workstation. Devices need careful handling using correctly designed collets, vacuum pickups or, with care, sharp tweezers.

Die Attach: Conductive epoxy or preform die attach is recommended. For preform die attach: Preform: AuSn (80% Au, 20% Sn); Stage Temperature: 290 °C, +/-5 °C; Handling Tool: Tweezers; Time: 1 min or less.

Wire Bonding: Wire Size: 0.7 to 1.0 mil in diameter (pre-stressed); Thermocompression bonding is preferred over thermosonic bonding. For thermocompression bonding: Stage Temperature: 250 °C ; Bond Tip Temperature: 150 °C; Bonding Tip Pressure: 18 to 40 gms depending on size of wire.

RoHS Compliant Parts - All Mimix products are RoHS compliant unless otherwise specified.

Ordering Information

Part Number for Ordering

CF001-03-000X

Description

Where "X" is RoHS compliant die packed in "V" - vacuum release gel packs or "W" - waffle trays



Proper ESD procedures should be followed when handling this device.